

I. Schéma zasilovače ADJ 635

*rezilovae  
odposlechu  
1W/8Ω*

Z.O.

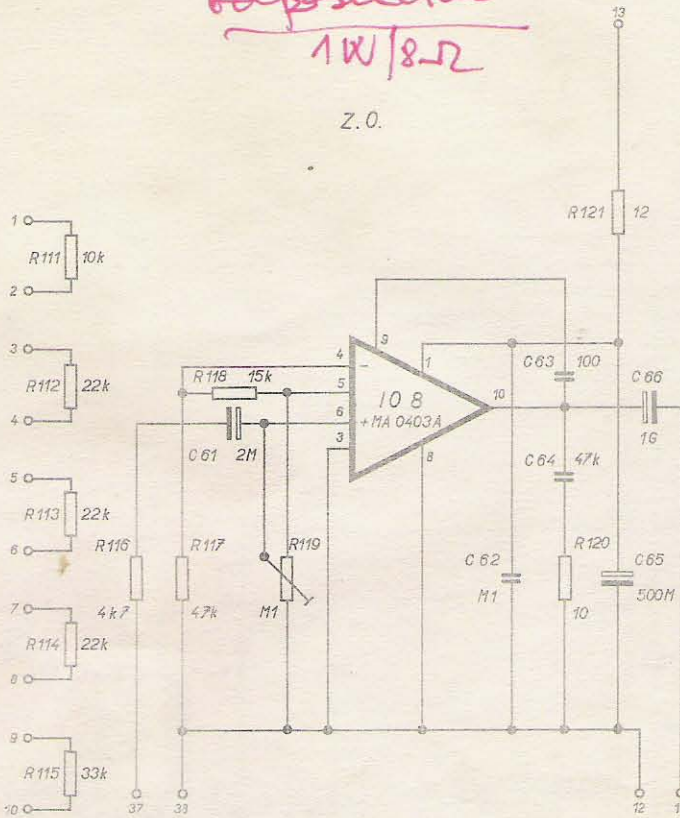

*spicikou  
mociilometr*

Z. Mo.

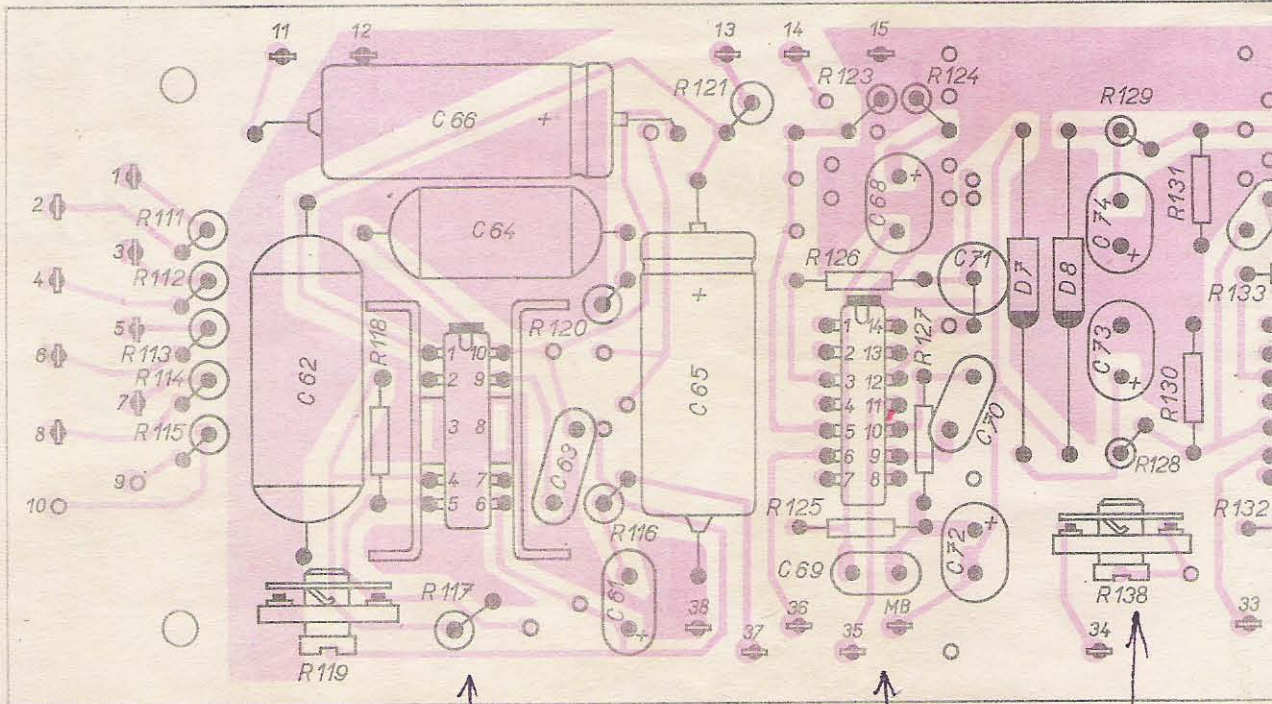
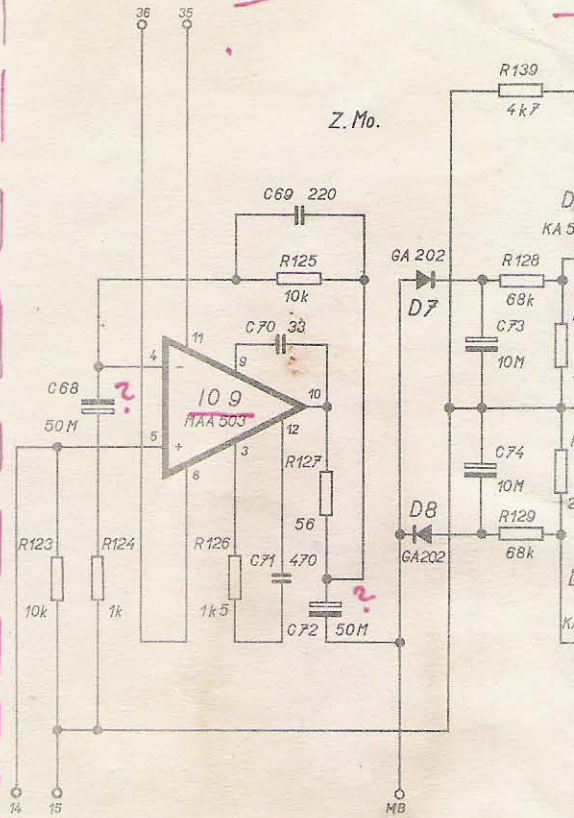

IO-08

IO-09

(MAA 503)

*regulace  
vychytky*

(MA)

*údel. stupňov  
reál. = 2*

*RC generator*

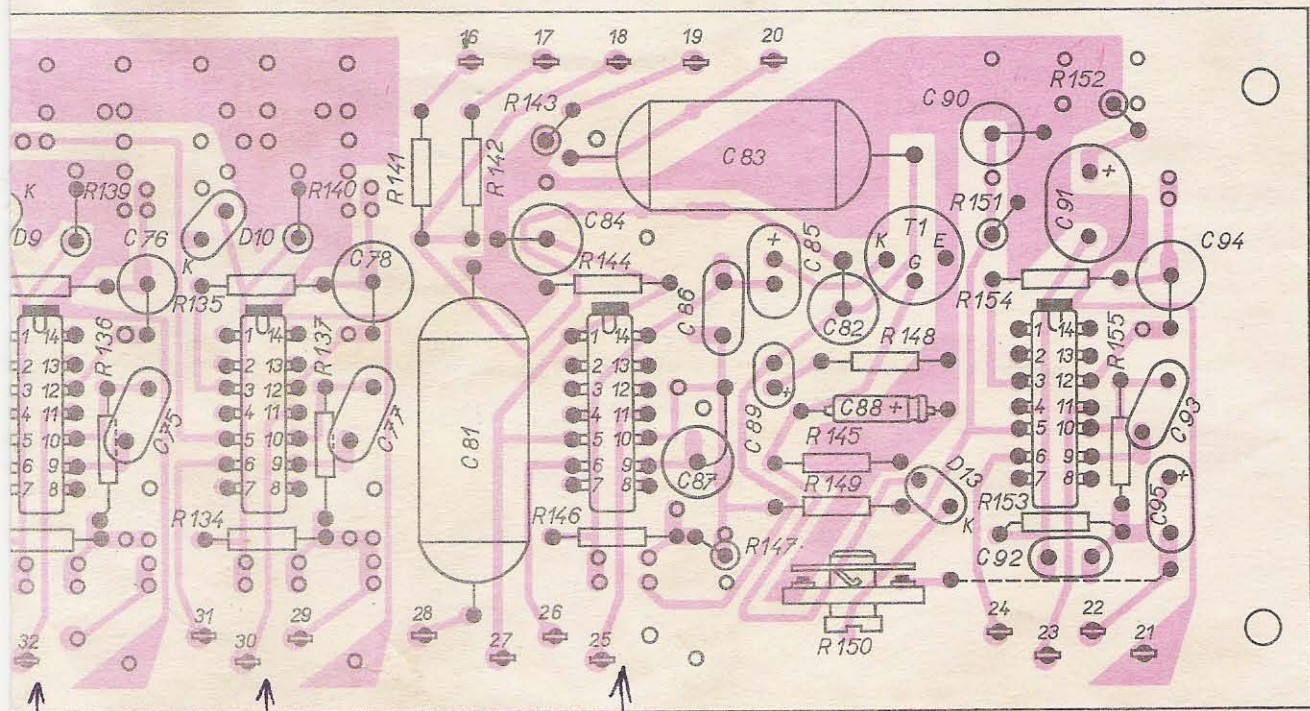
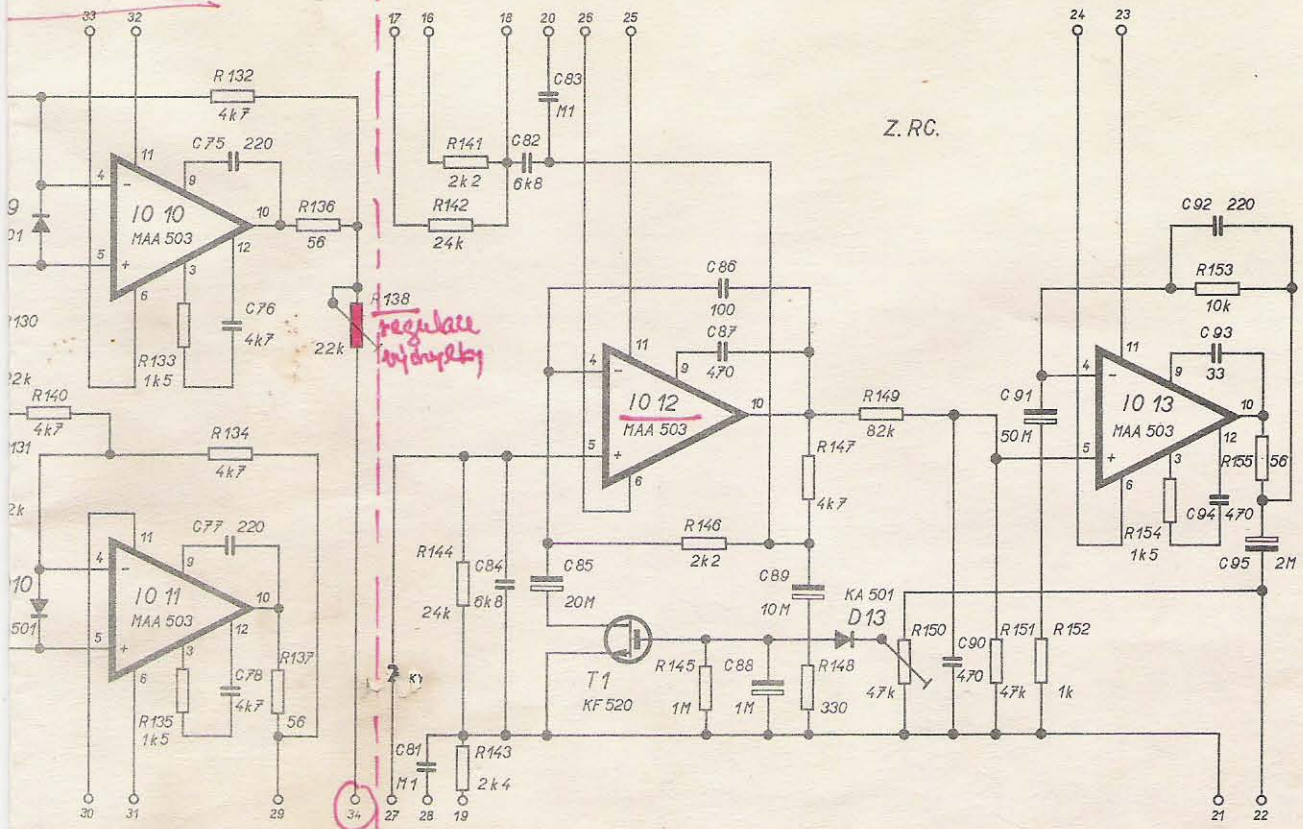

IO-10  
(MAA 503)

IO-11  
(MAA 503)

IO-12  
(MAA 503)

IO-13  
(MAA 503)

Príloha VIII. Doska kontrolného panela 3AK 060 75

*od mēr. modulometrem*

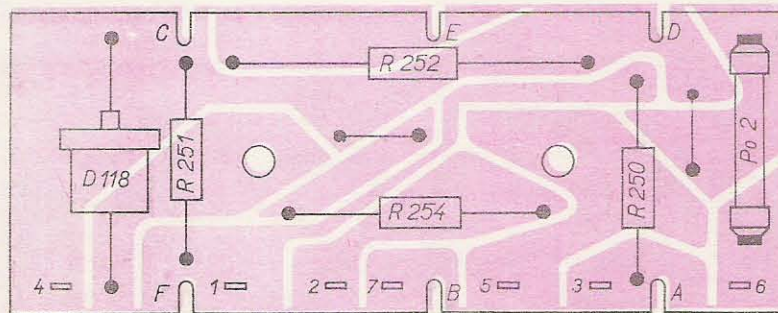
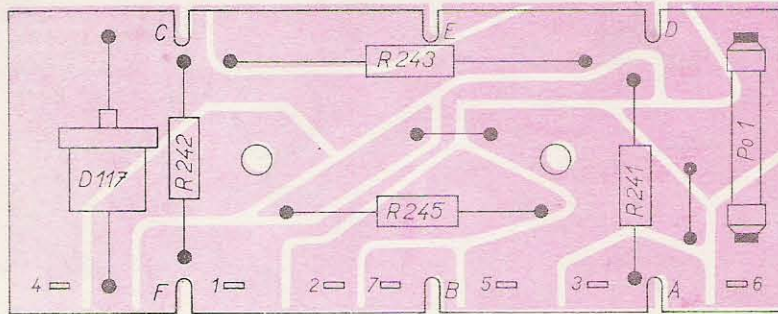

Príloha XII. Doska prepojovacia

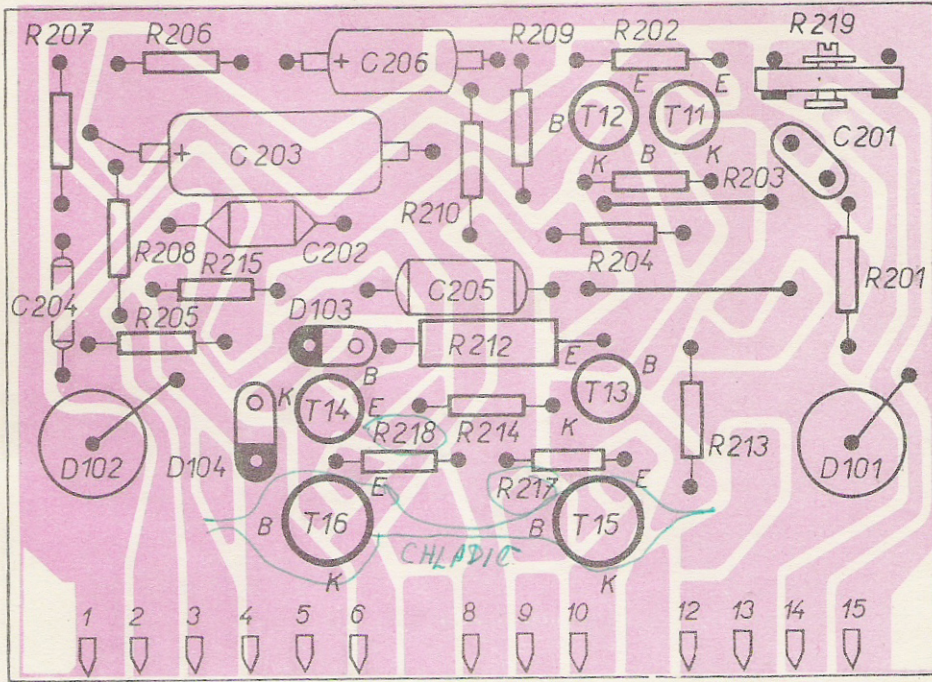

R218, R214 - 10Ω

Priloha X. Doska vstupného zosilňovača

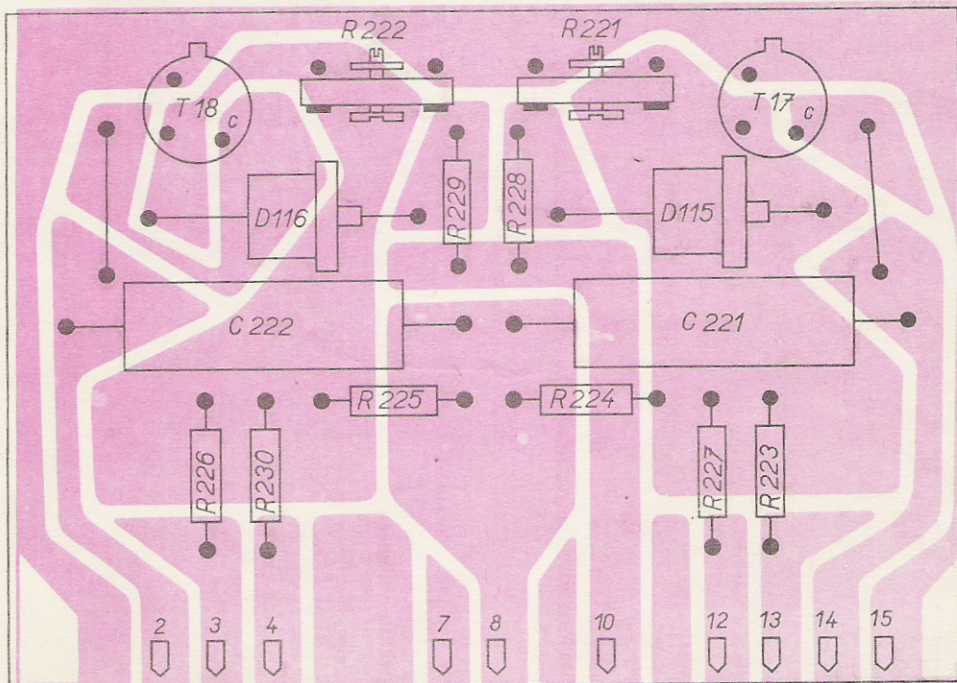

Priloha XI. Doska elektronickej poistky

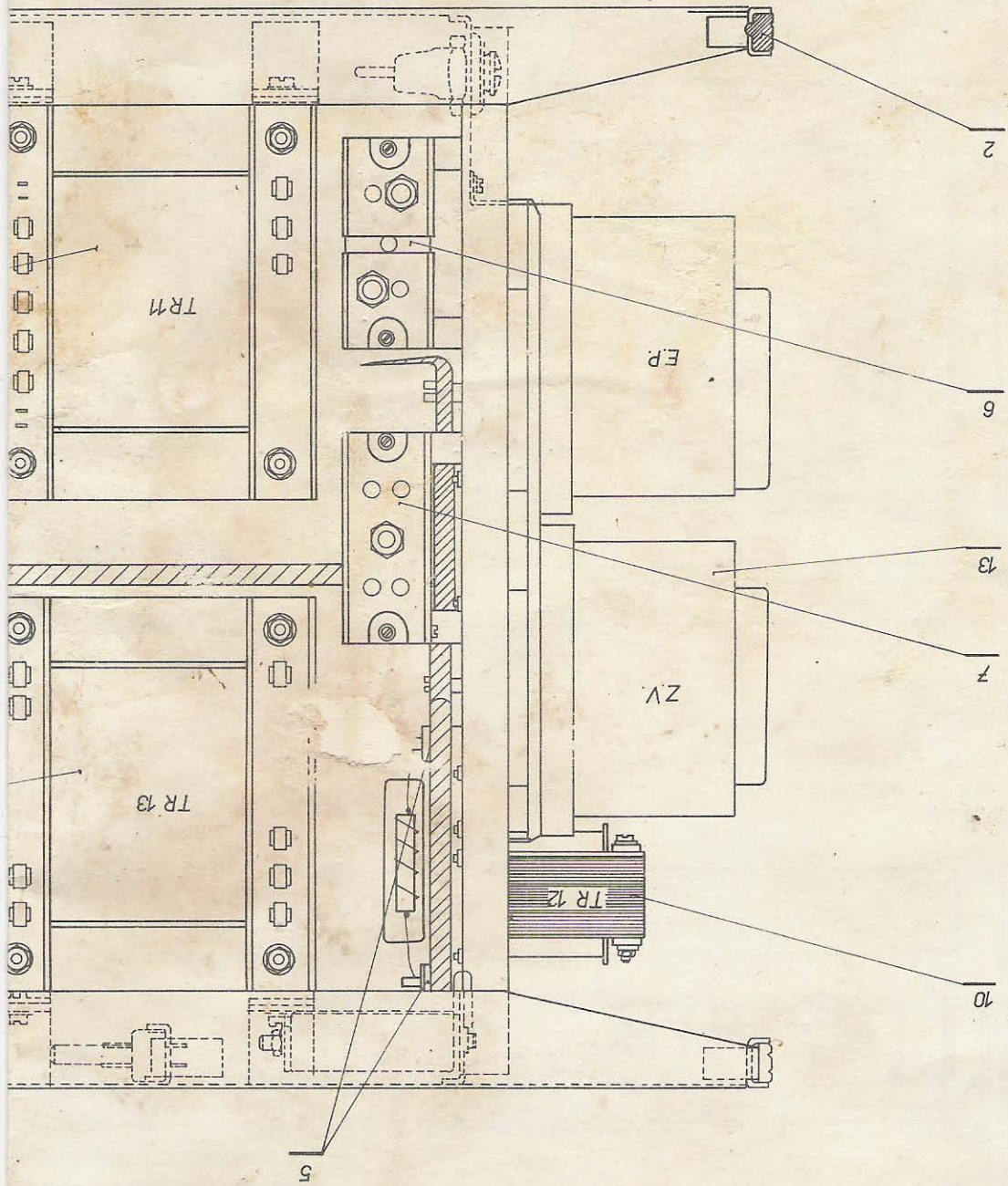



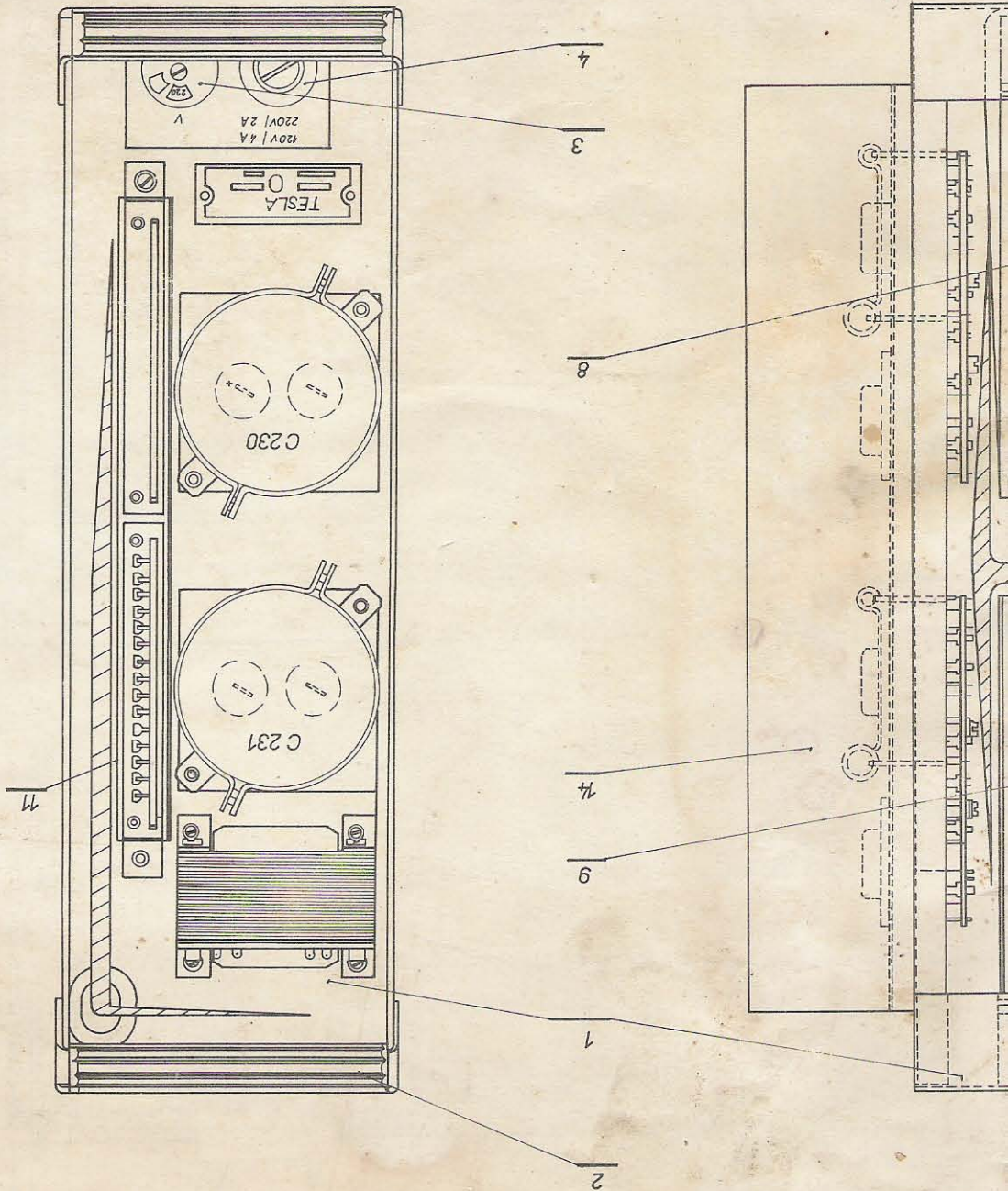

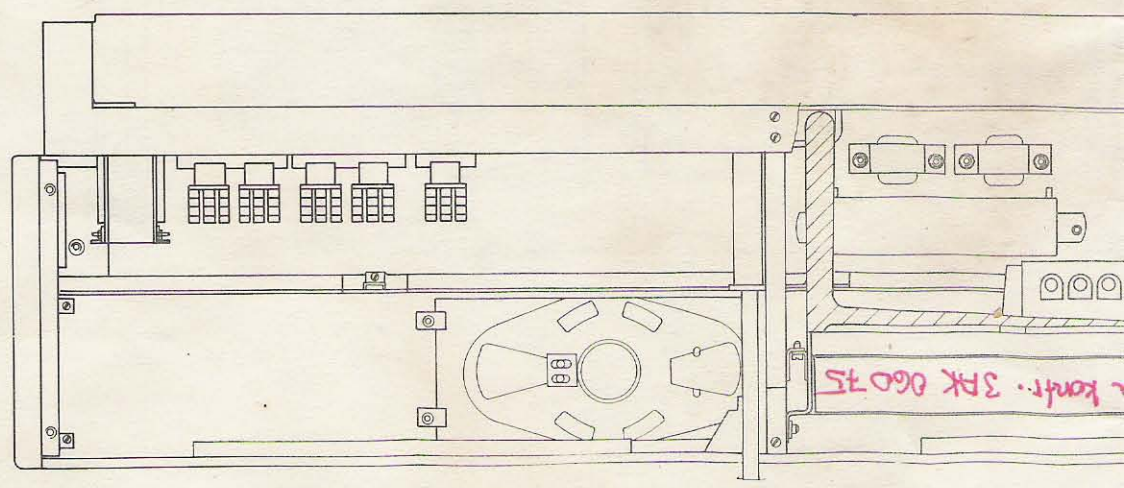
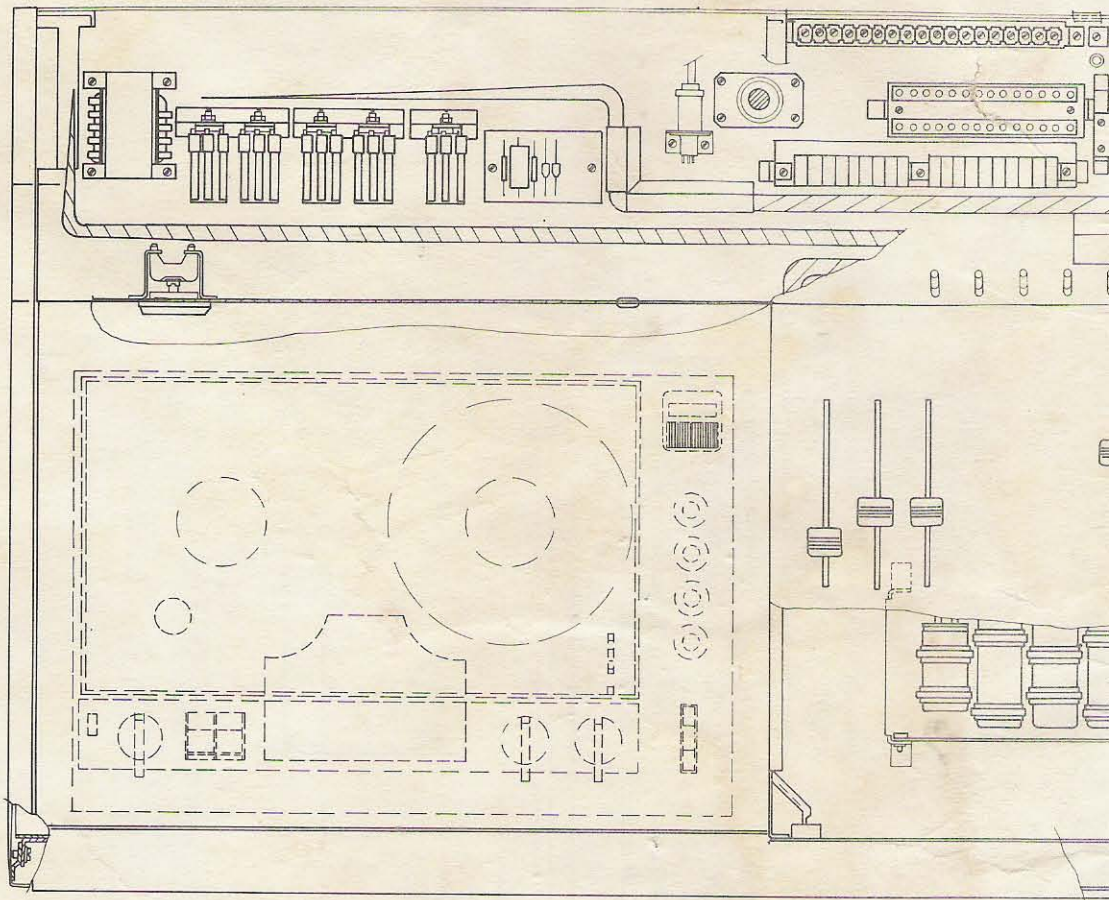

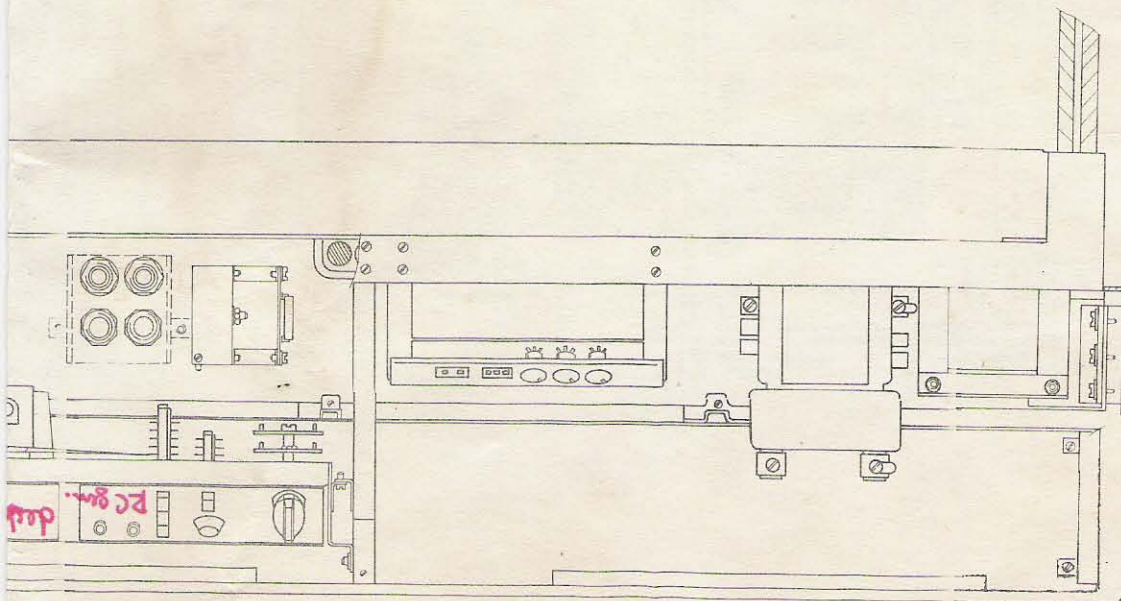
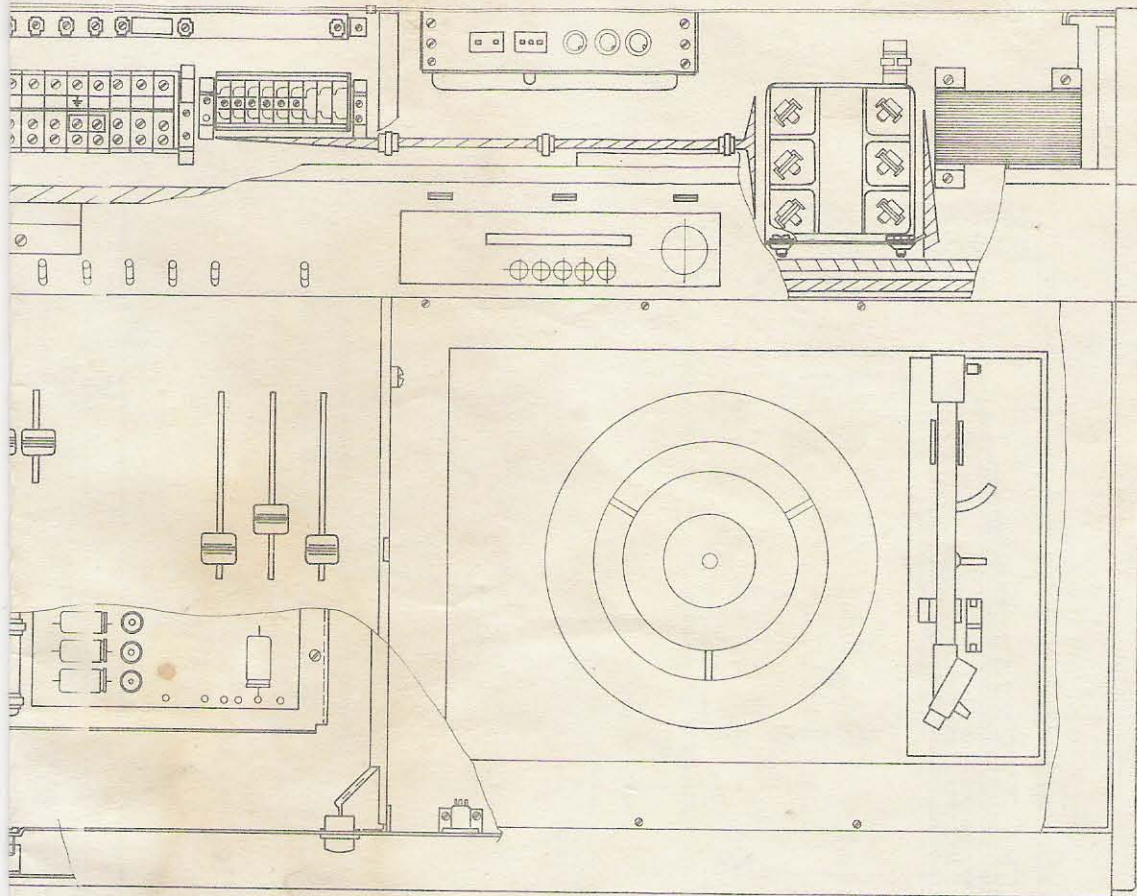

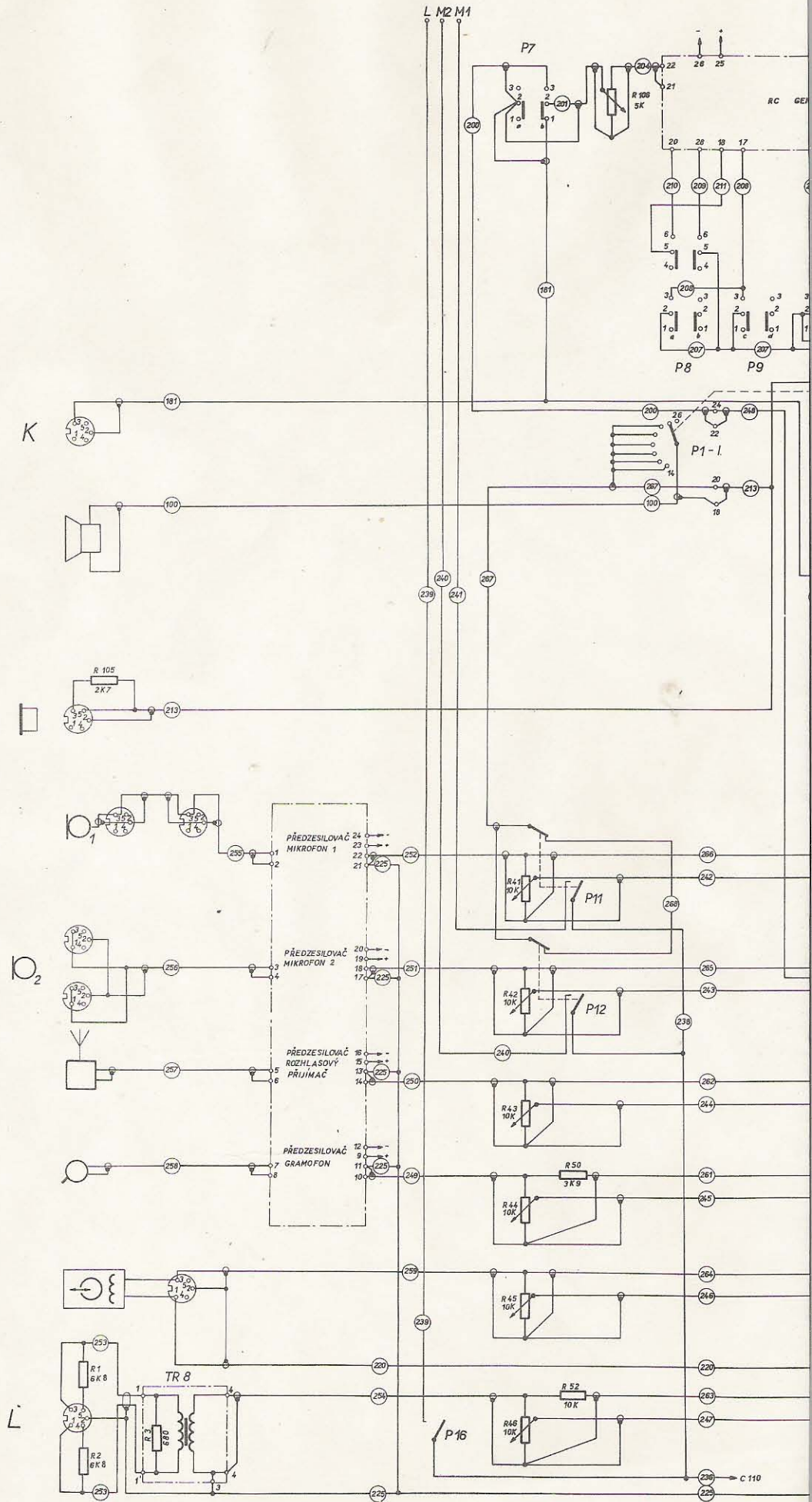

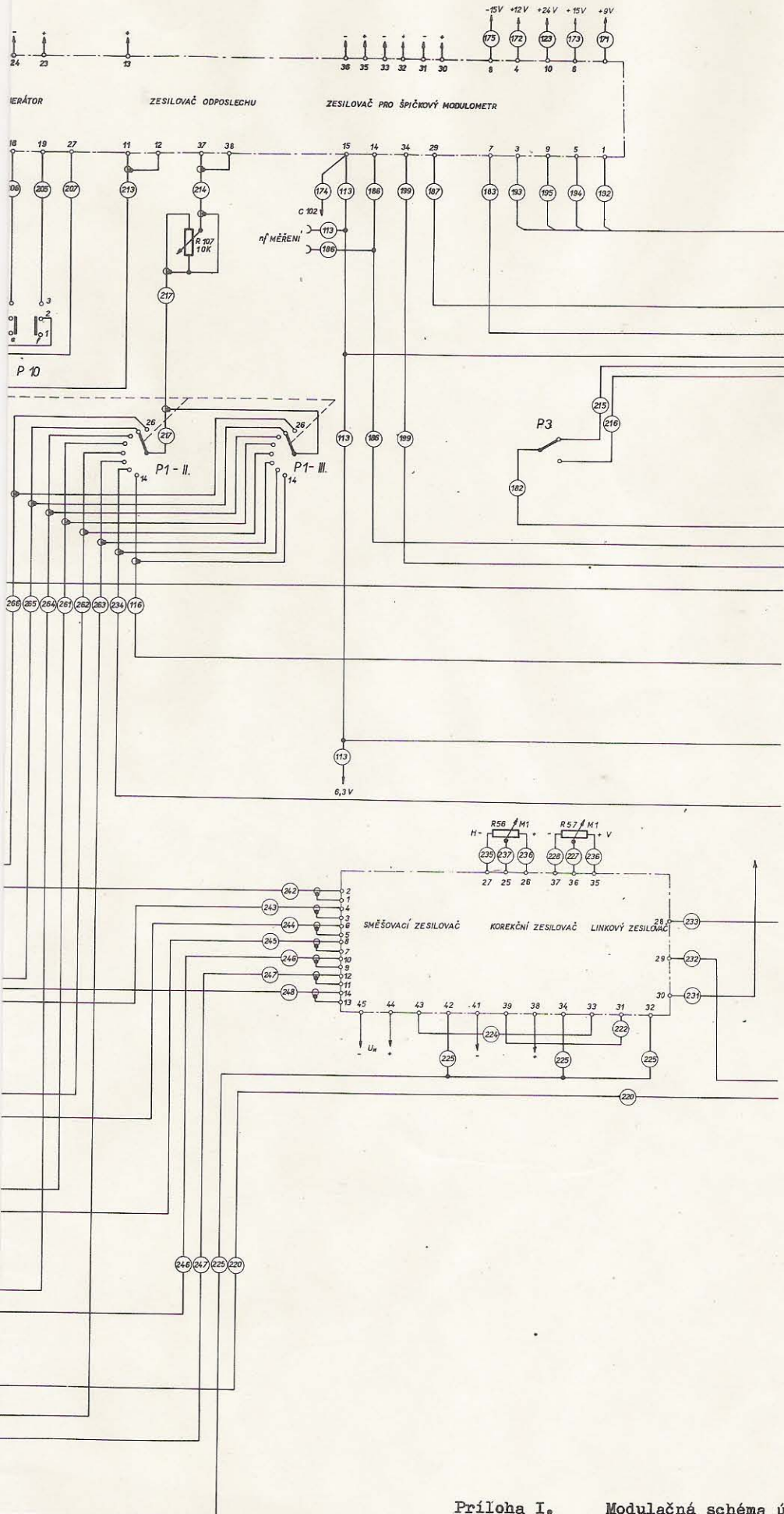

Príloha I. Modulačná schéma ústredne

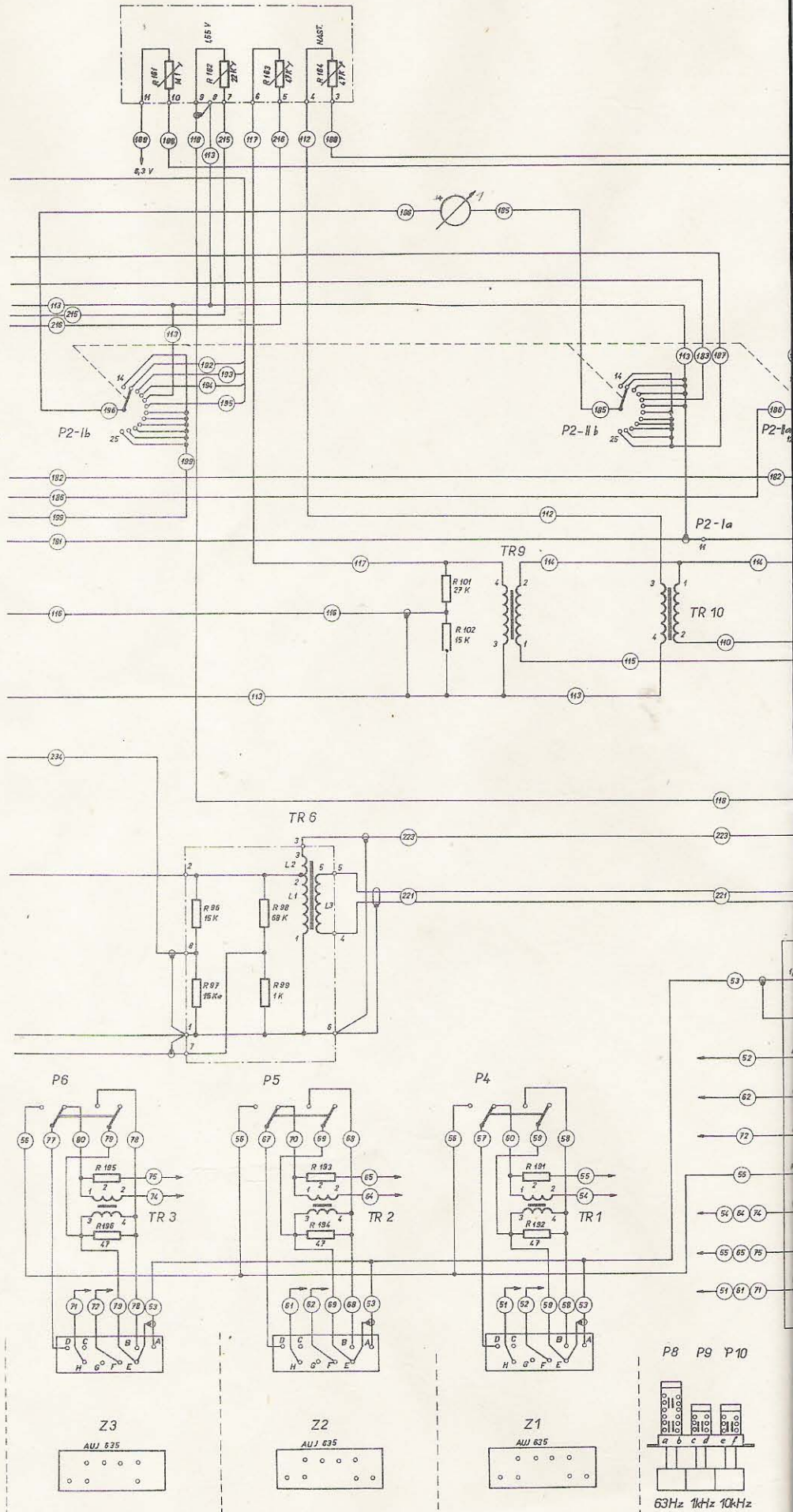

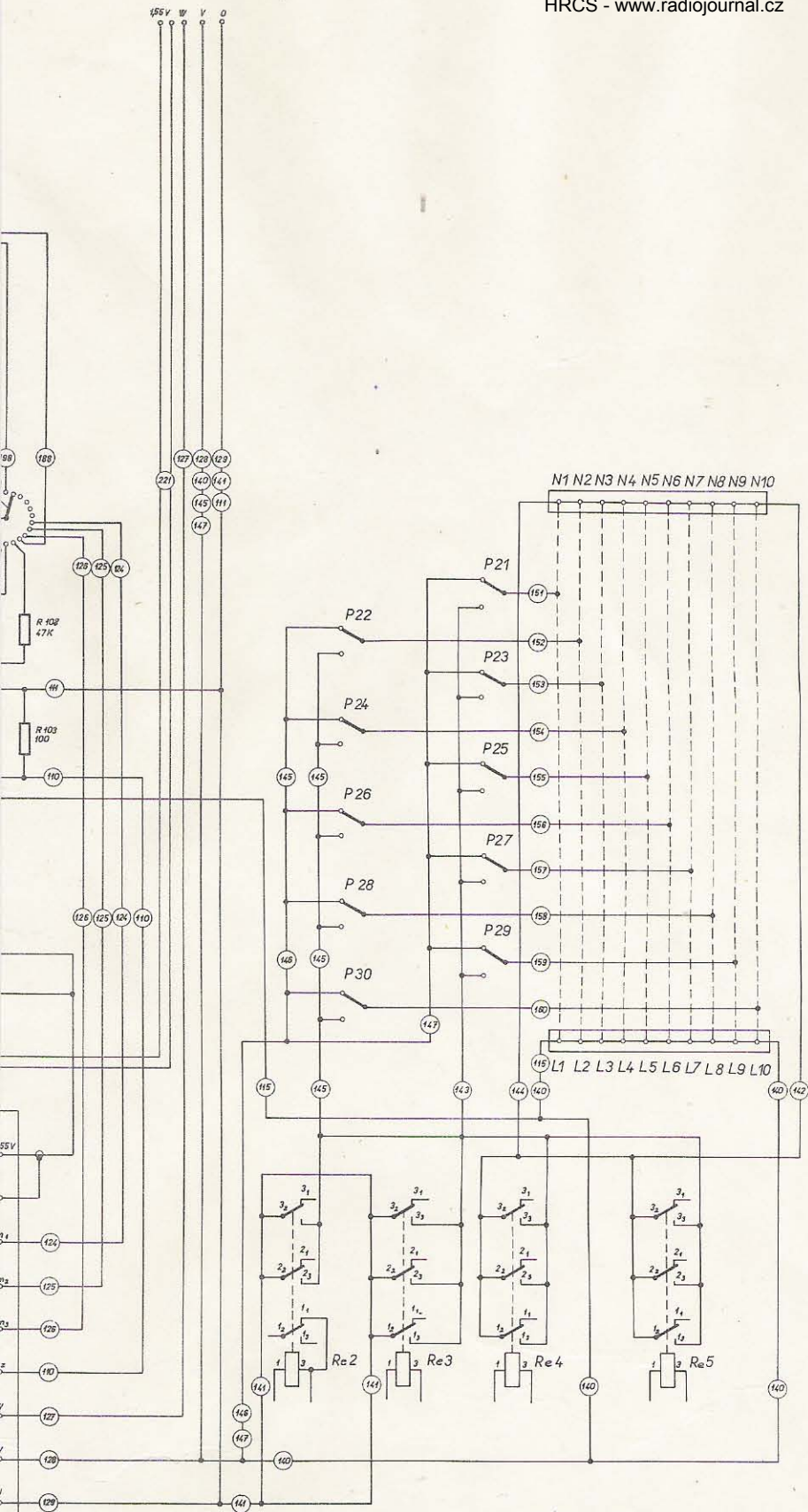

RELE RE 1 ÷ 5 TYP RP 402

1	2	3
1 <sub>1</sub>	2 <sub>1</sub>	3 <sub>1</sub>
1 <sub>2</sub>	2 <sub>2</sub>	3 <sub>2</sub>
1 <sub>3</sub>	2 <sub>3</sub>	3 <sub>3</sub>

P7

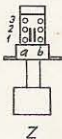

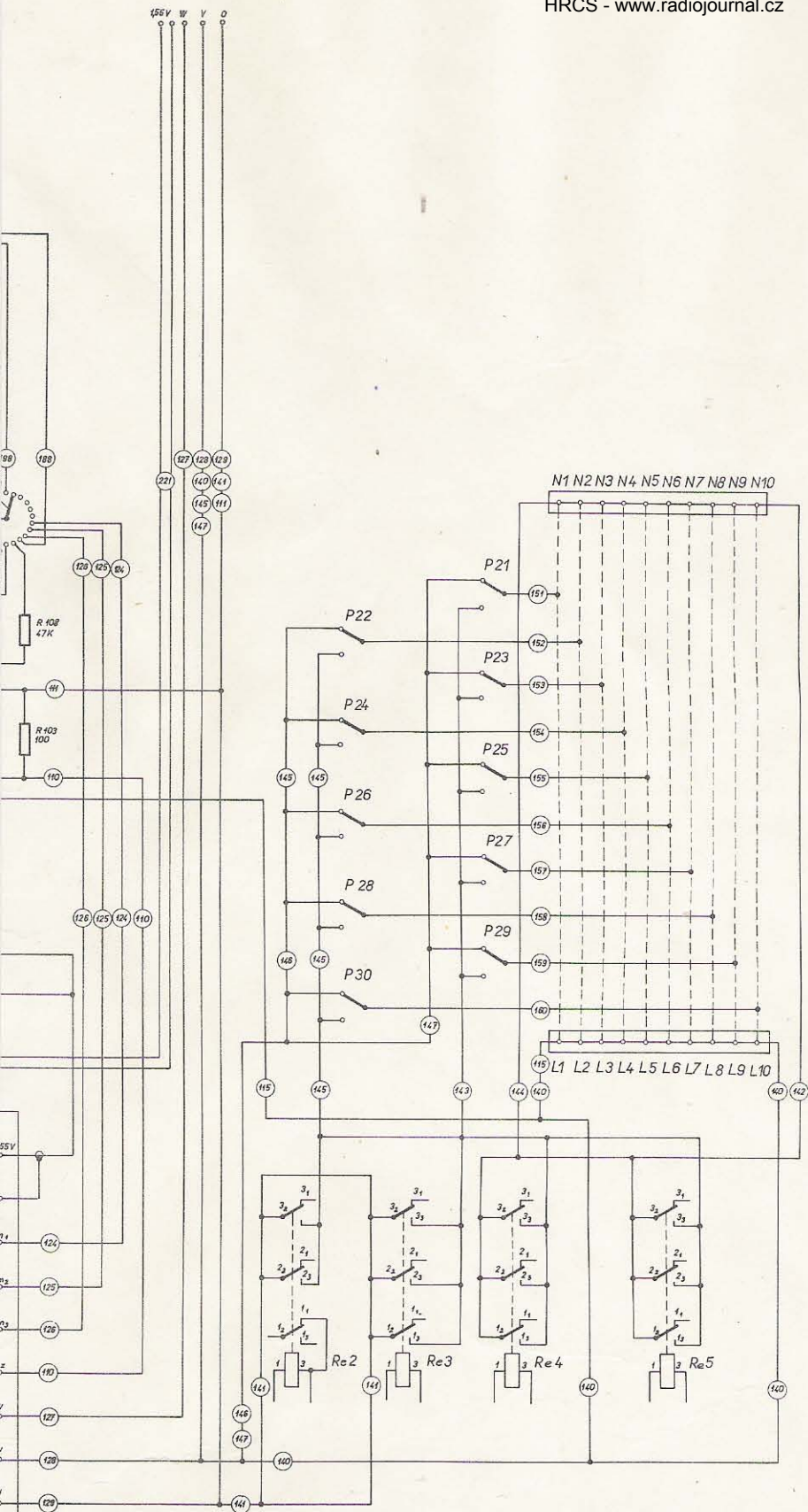

RELÉ RE 1 ÷ 5 TYP RP 102

1	2	3
1 <sub>1</sub>	2 <sub>1</sub>	3 <sub>1</sub>
1 <sub>2</sub>	2 <sub>2</sub>	3 <sub>2</sub>
1 <sub>3</sub>	2 <sub>3</sub>	3 <sub>3</sub>

P7

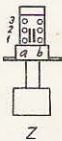



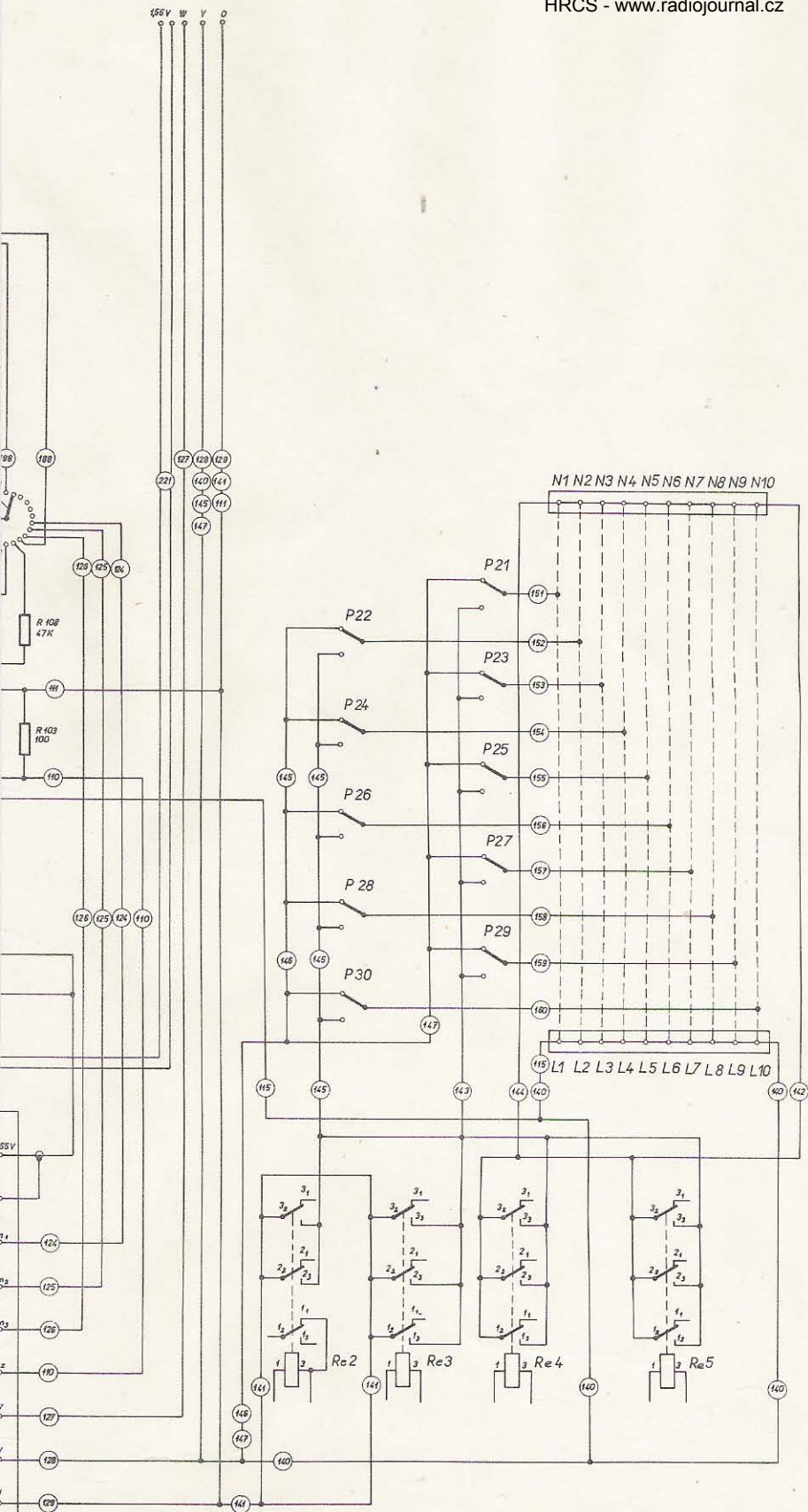

P7

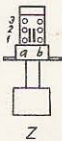

RELÉ RE 1 ÷ 5 TYP RP 102

1	2	3
1 <sub>1</sub>	2 <sub>1</sub>	3 <sub>1</sub>
1 <sub>2</sub>	2 <sub>2</sub>	3 <sub>2</sub>
1 <sub>3</sub>	2 <sub>3</sub>	3 <sub>3</sub>

POHLED „P“

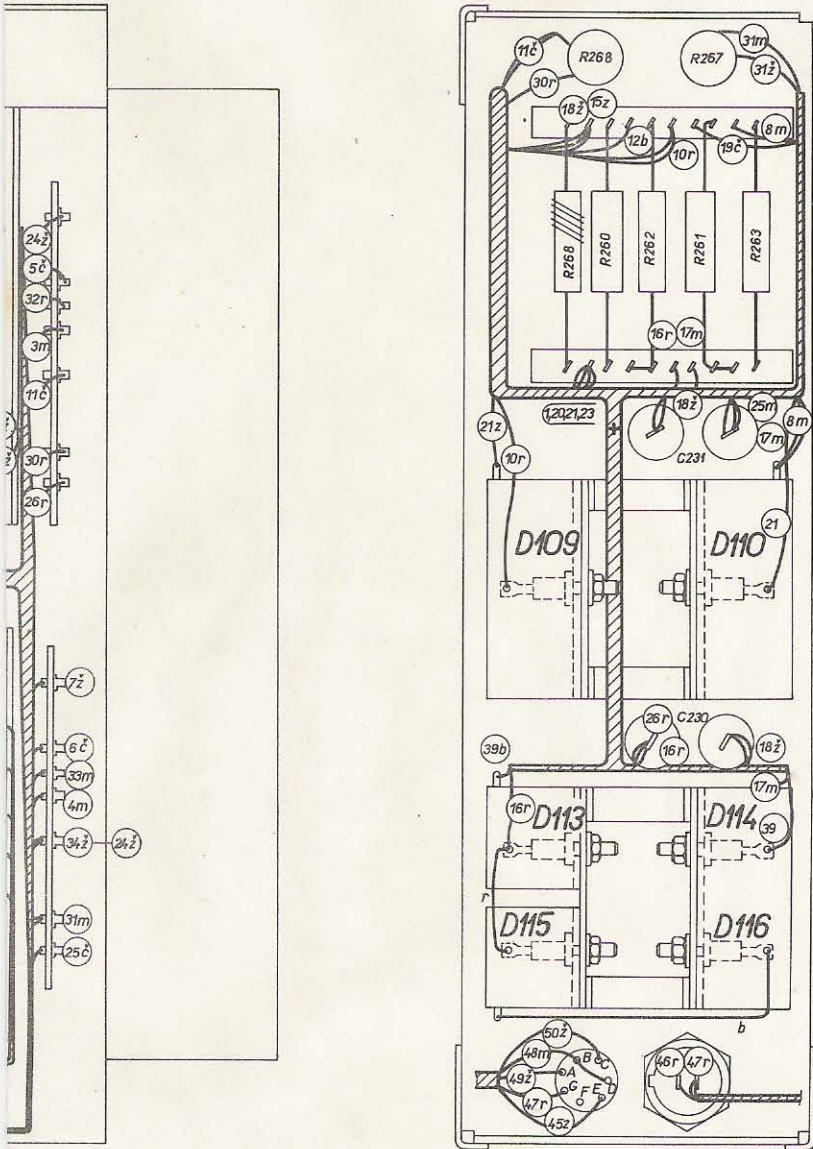

DESKA 3 AK 826 64,65

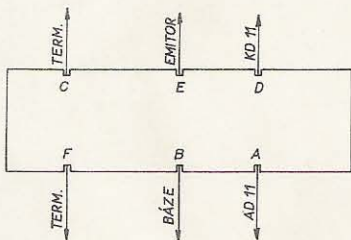

KONCOVÝ STUPEŇ AUJ 635

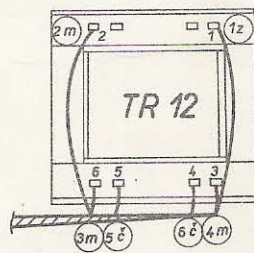
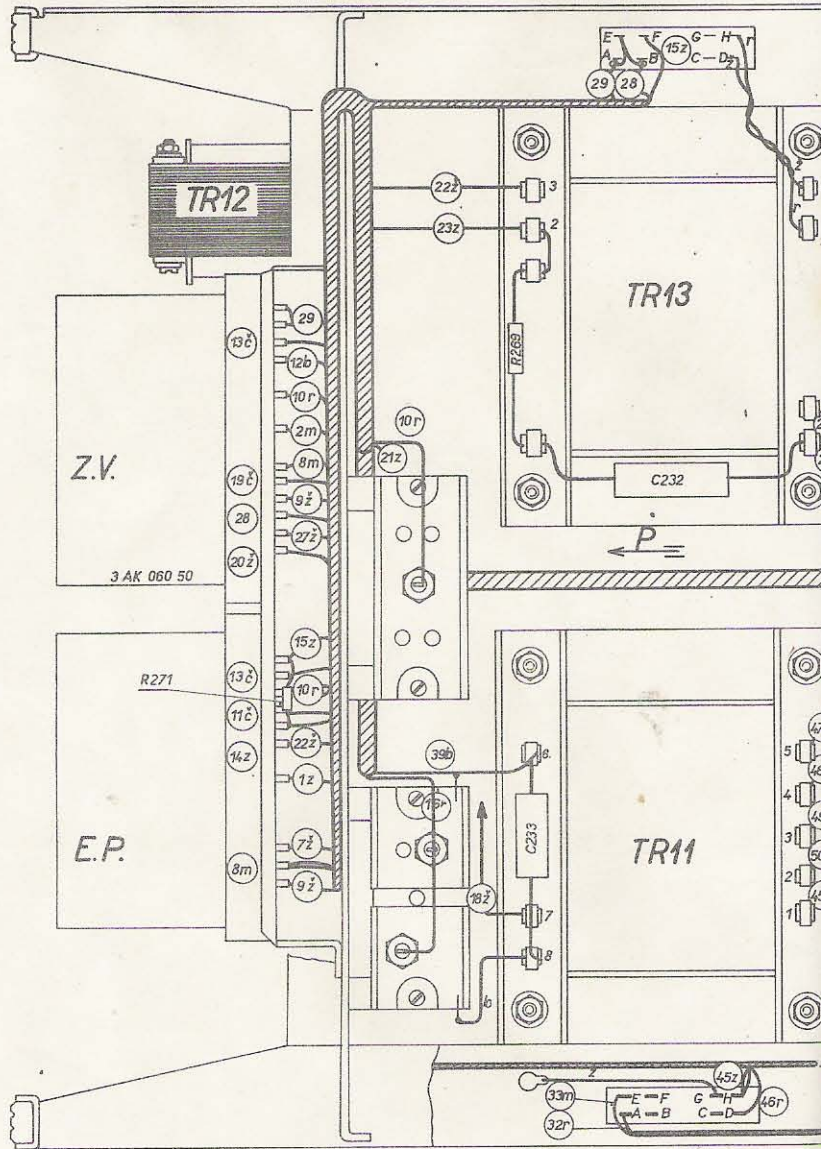

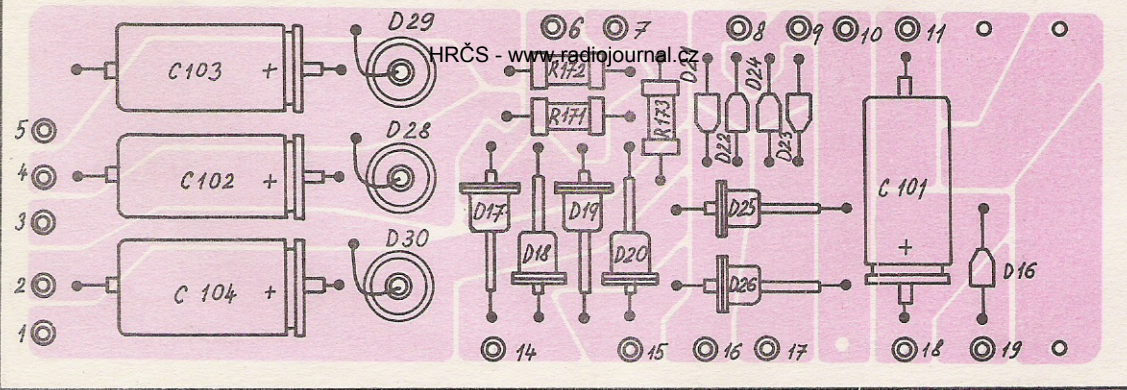

Príloha III. Napájacia doska 3AK 060 74

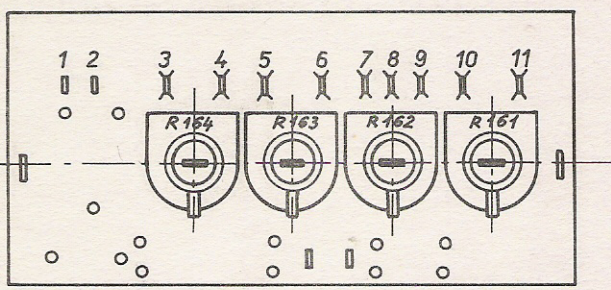

Príloha IV. Doska s potenciometrami

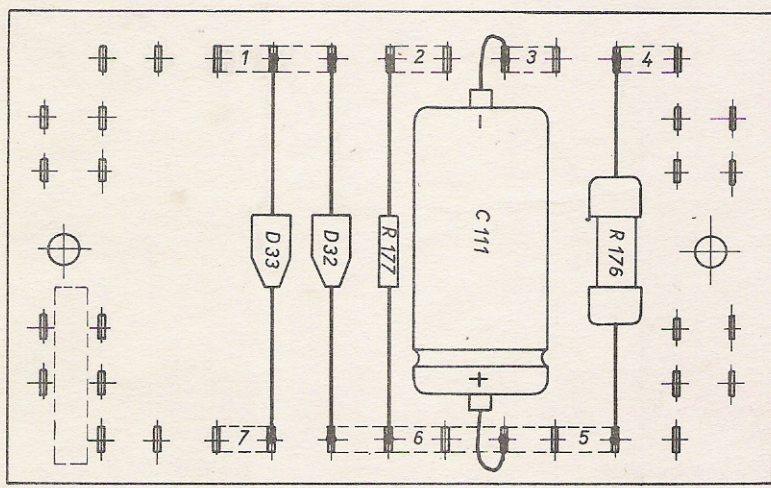

Príloha V. Montážna jednotka

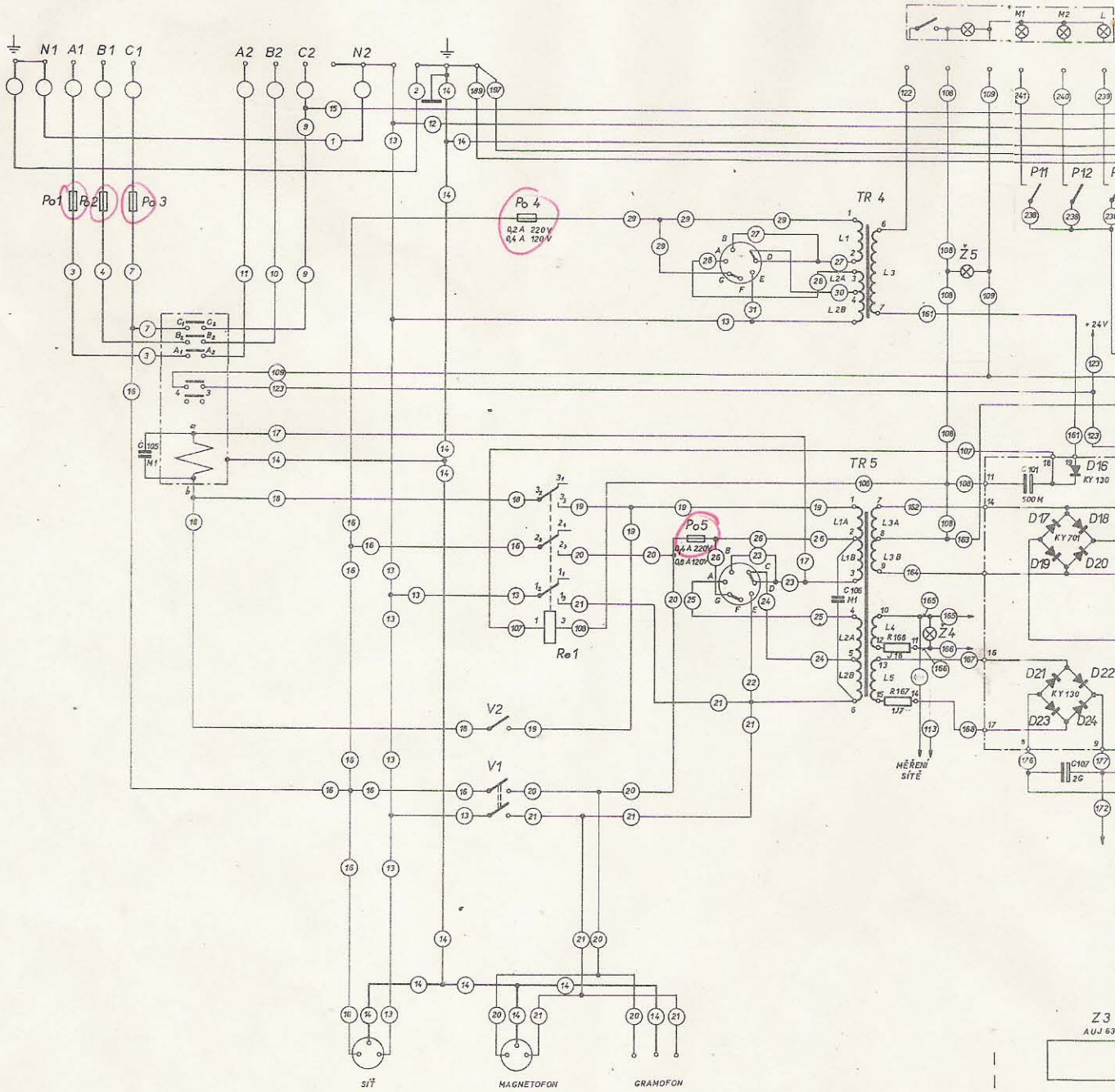

RELE RE 1-5 TYP RP 152

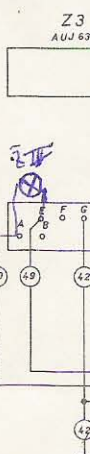
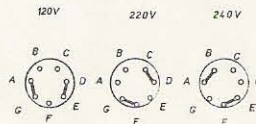
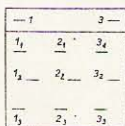

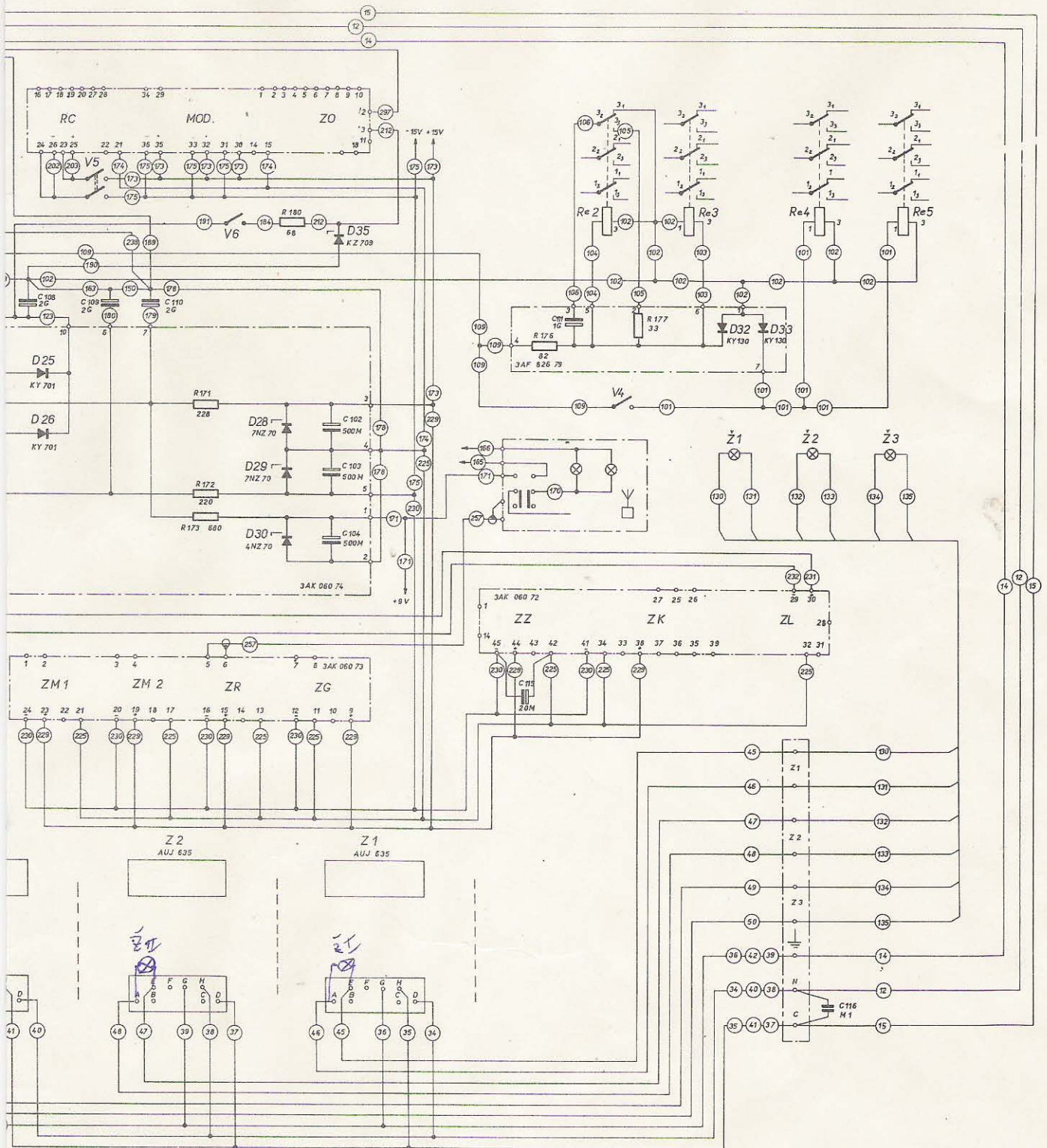

Príloha II. Napájacia schéma ústredne

1 2 3 4 5 6 7 8 9 10 11 12 13 14 15 16 17 18 19 20 21 22 23 24 25 26 27 28 29 30 31 32 33 34 35 36 37 38 39 40 41 42 43 44 45 46 47 48 49 50 51 52 53 54 55 56 57 58 59 60 61

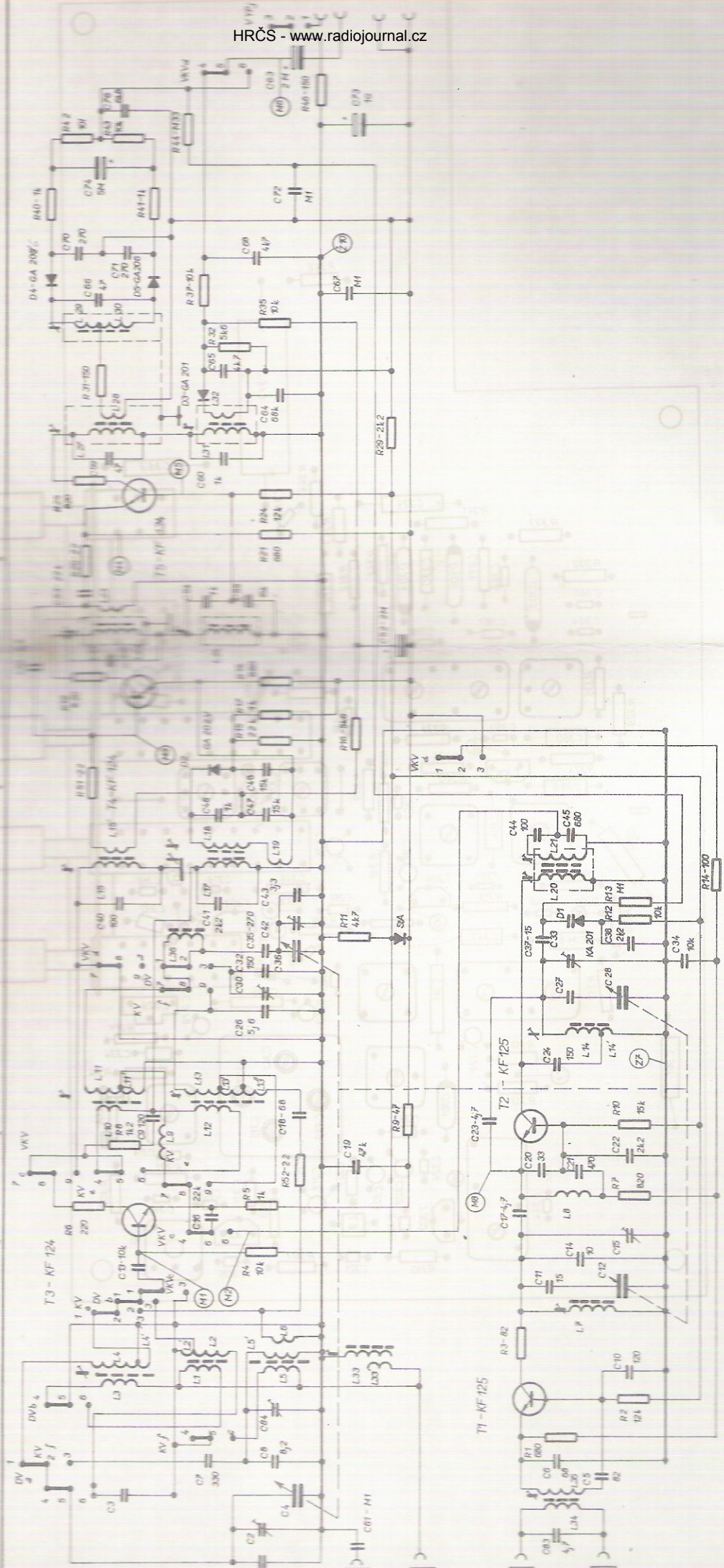

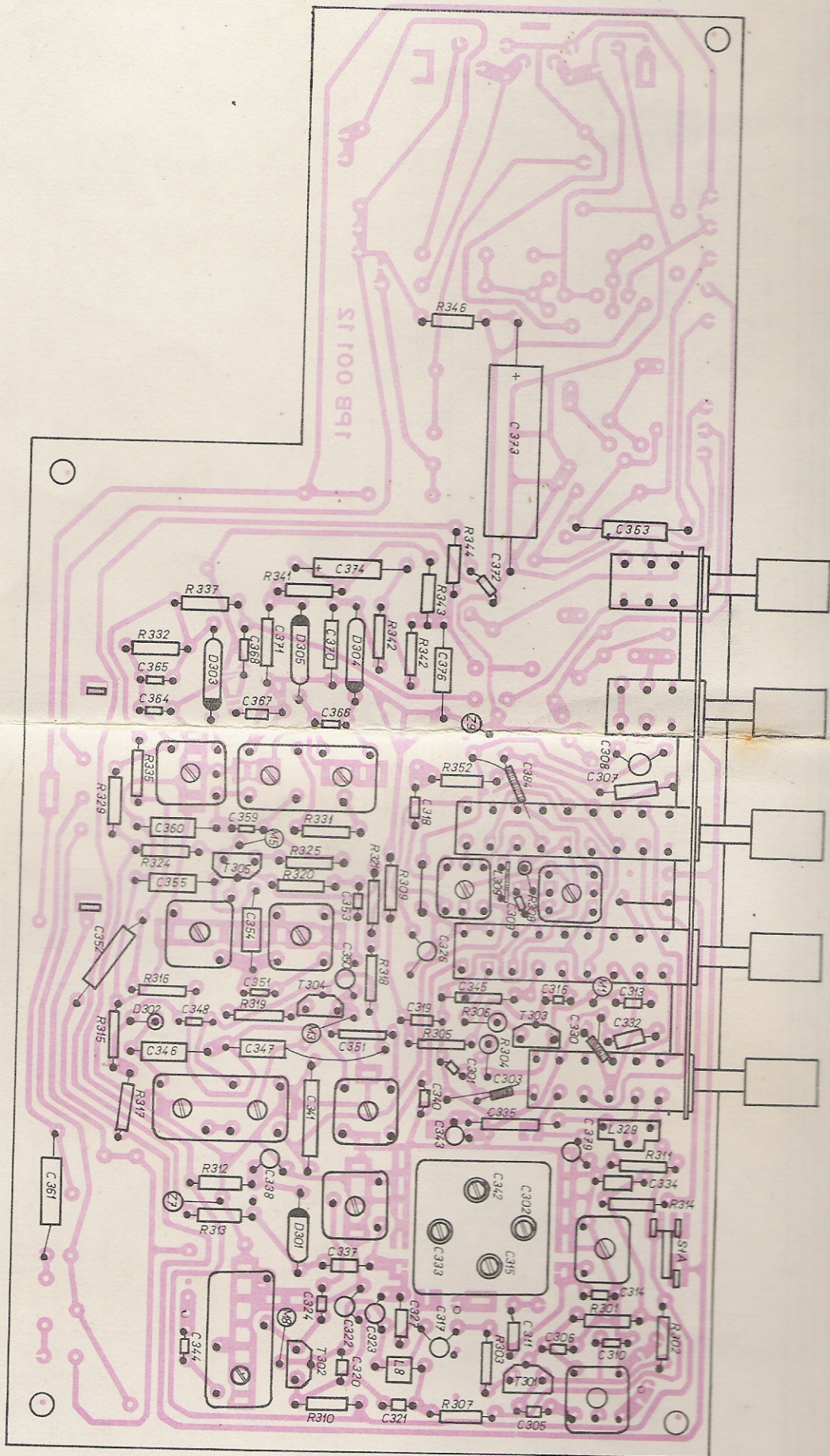

Príloha XVII. Doska prijímača

RADIO



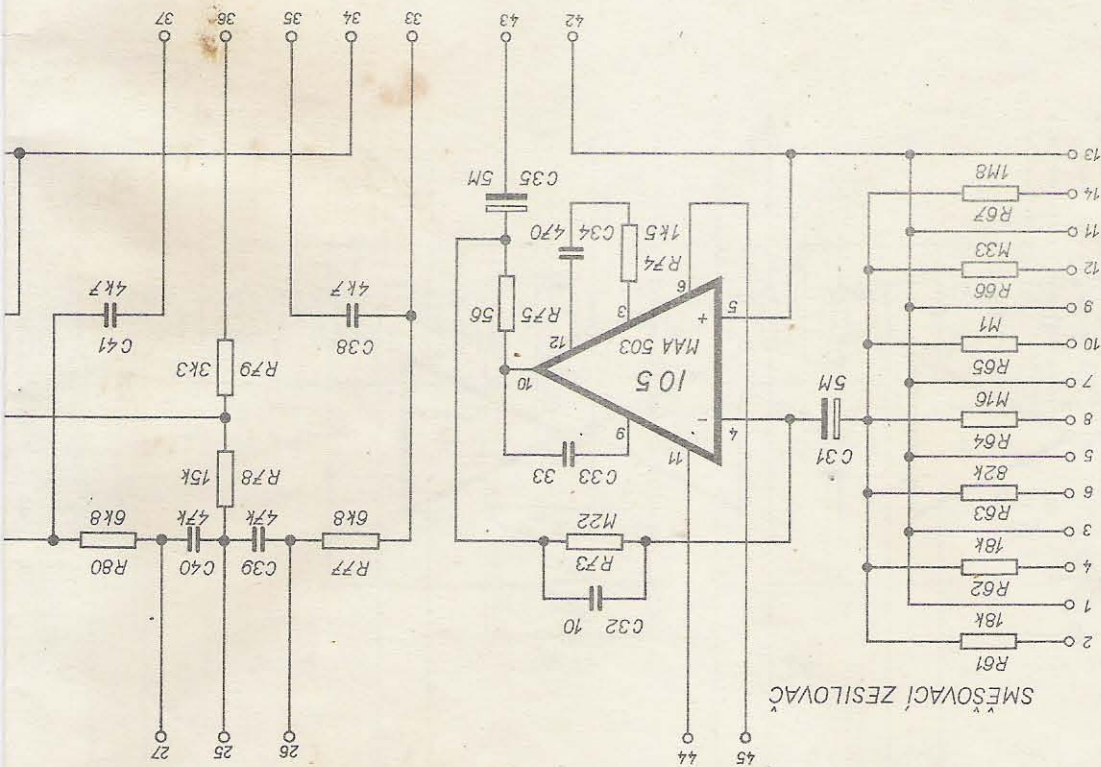
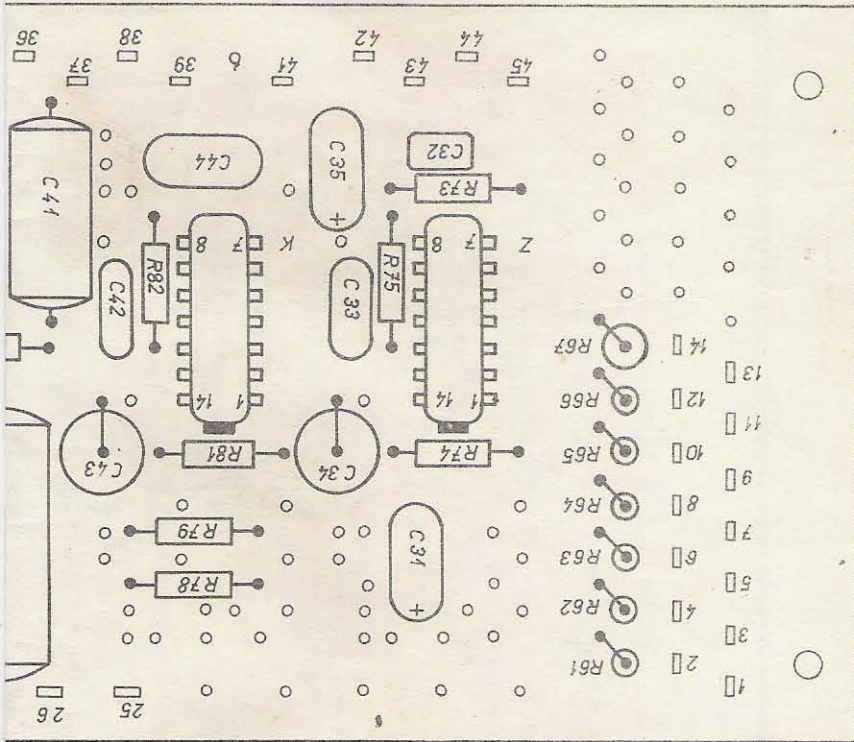

SMĚŠOVACÍ ZESILOVAČ

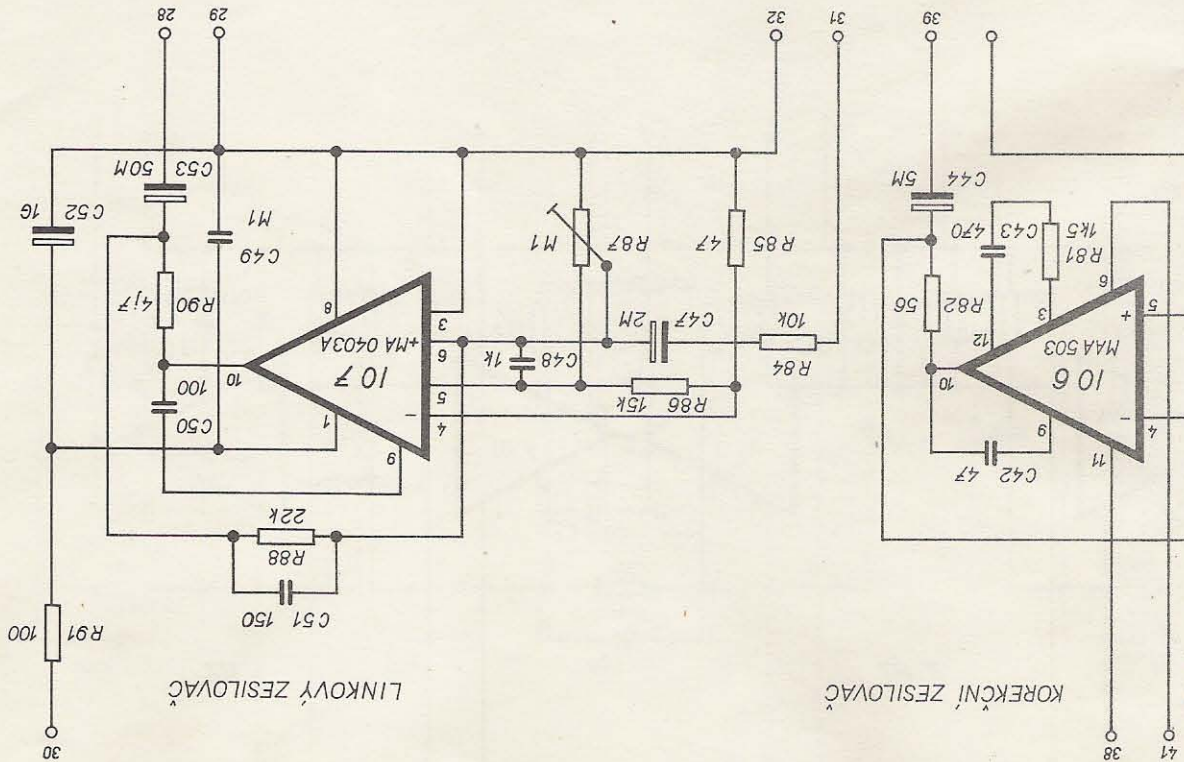
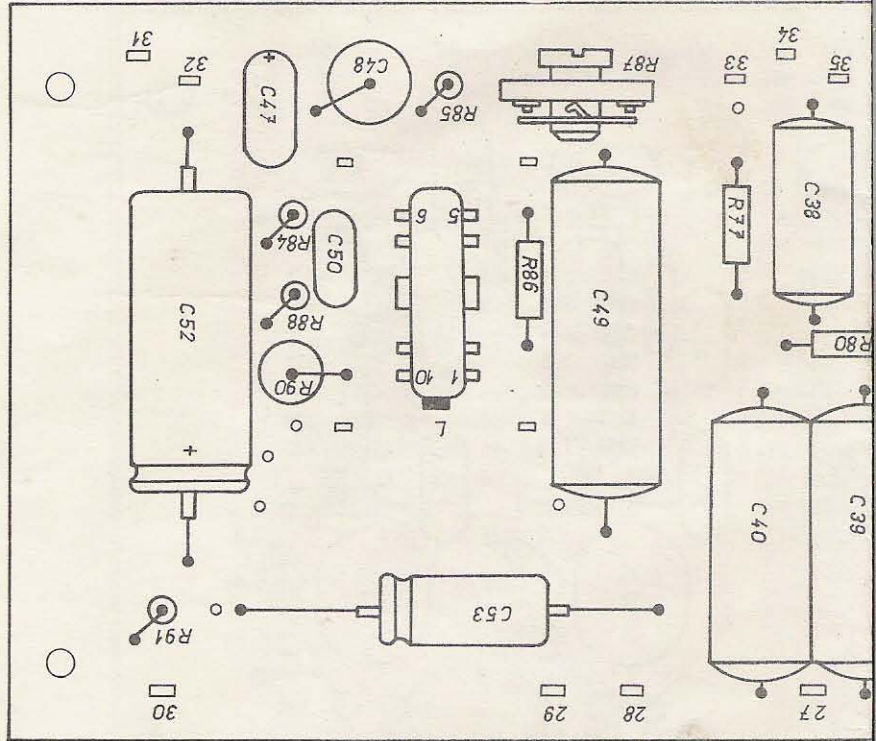

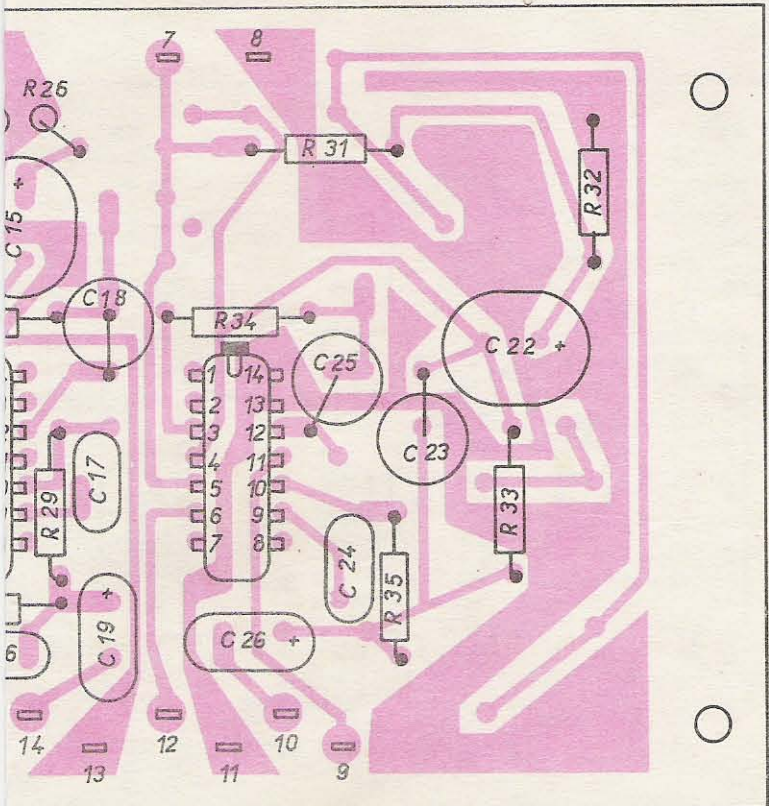
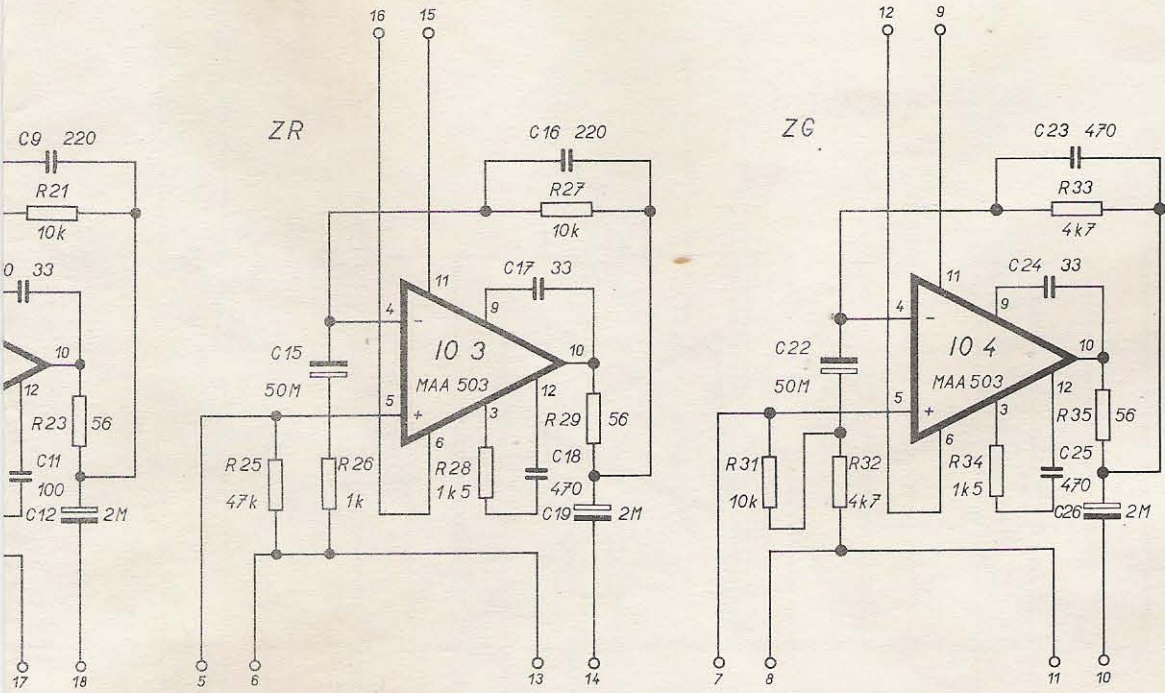

Príloha VI. Doska vstupných zosilňovačov 3AK 060 73

